



Mobile Office Spaces



03 De luxe

		10'	20'	40'
Container	New (One trip)	1	1	1
Certification	CSA electrical certification	inclus	inclus	inclus
	CSA W47.1 welding certification	inclus	inclus	inclus
Sliding window	48" x 36" with protective grille	1	2	4
Men's door	36" x 80", with 12" x 18" glass, with panic bar and deadbolt	1	1	1
Isolation urethane 2"	Accessible fork holes	1	1	1
Interior finish	Vinyl	1	1	1
Floor covering	Tiles with 4" mouldings at bottom of walls	1	1	1
Hooks	1 set of 5 coat hooks	1	1	1
Electric panel	100 amps	1	1	1
Air conditioning	10,000 BTU with protective grilles	1	1	1
Heating	2000 watts	1	2	4
	Wall-mounted thermostat	1	1	2
Electrical outlets	15 amps with USB socket	2	4	8
Lighting	Interior, 48" LED neon	1	2	4
	Outdoor, LED 20 watts	1	1	1
	Wall switch	1	1	1

Conteneurs Experts

1201, montée Labossière, Vaudreuil-Dorion (Québec) J7V 4J3 • 1 888 482-9
www.conteneurexperts.com







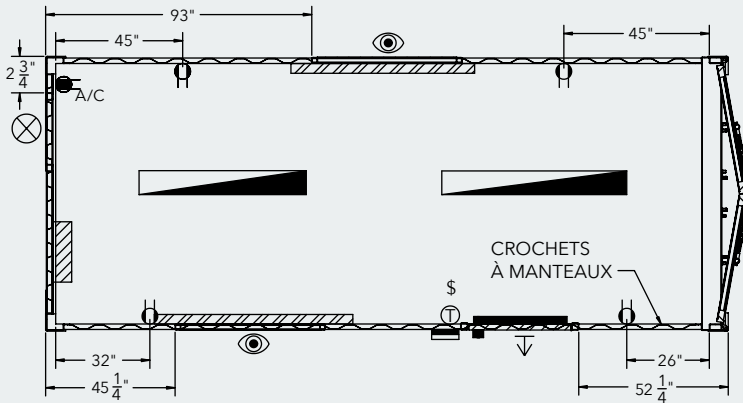
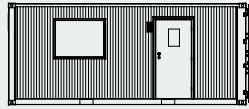

03 De luxe 20'

Interior dimensions with finish

Length Height Width
18' 9" 7' 5½" 7'



Electrical legend :

-  15A USB socket
-  Electric panel
-  **Thermostat**
-  T
-  \$ Switch
-  Neon
-  Electric baseboard

Aperture legend :

-  Windows 48" X 36"
-  MDR 36 "X80" door
-  A/C 10,000 BTU

03 De luxe 40'

Interior dimensions with finish :

Length Height Width
38' 8" 7' 5½" 7'

