



MobileOffice Space



01 L'économique

		10'	20'	40'
Container	User	1	1	1
Certification	CSA electrical certification A277	included	included	included
	CSA W47.1 welding certification	included	included	included
Sliding window	36" x 36" without protective grille	1	1	2
Men's door	36" x 80", with handle and deadbolt	1	1	1
2" urethane insulation	Accessible fork holes	1	1	1
Interior finish	Aspenite	1	1	1
Floor covering		–	–	–
Hooks		–	–	–
Electric panel	100 ampères	1	1	1
Air conditioning		optional	optional	optional
Heating	1500 watts	1	2	4
	Wall-mounted thermostat	1	1	2
Electrical outlets	15 amps ampères	1	2	4
Lighting	Interior, 48" LED neon	1	2	4
	Wall switch	1	1	1

Conteneurs Experts

1201, montée Labossière, Vaudreuil-Dorion (Québec) J7V 4J3 • 1 888 482-9674

www.conteneursexperts.com



01





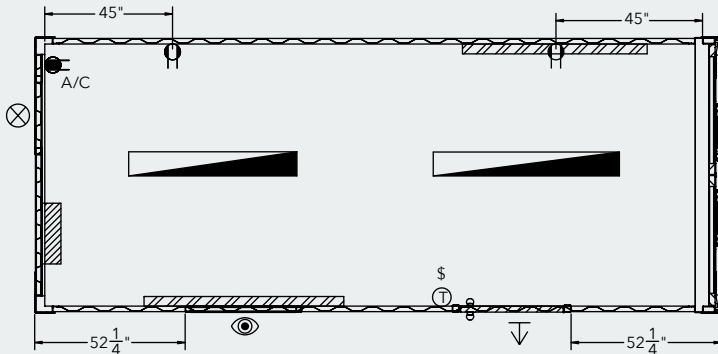
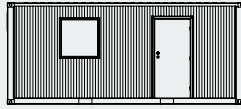

L'économique 20'

Interior dimensions with finish :



Length	Height	Width
18' 9"	7' 5½"	7'



Electrical legend :

-  110V / USB 15A power socket
-  Electric panel
-  Thermostat
-  Switch
-  Neon
-  Electric baseboard

Aperture legend :

-  36 "X36" window
-  MDR 36 "X80" door
-  A/C 10,000 BTU (optional)

01

L'économique 40'

Interior dimensions with finish :

Length	Height	Width
38' 8"	7' 5½"	7'

